

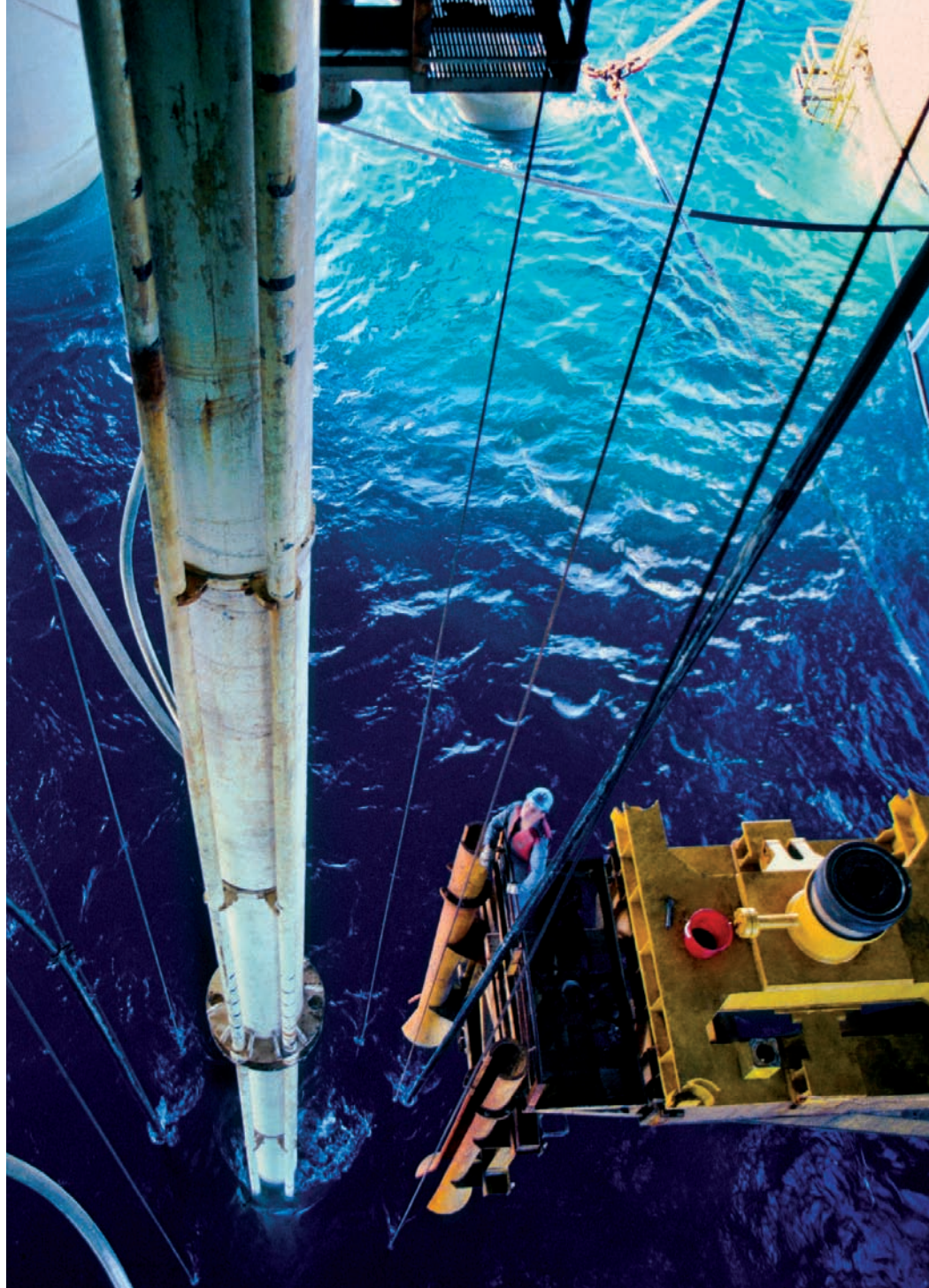

aerospace
climate control
electromechanical
filtration
fluid & gas handling
hydraulics
pneumatics
process control
sealing & shielding



Electronic Condensate Drains

ecodrain ED series for compressed air
and industrial gases



Electronic Condensate Drains

ecodrain ED3000 series

Features and Advantages

Electronic condensate drains of the ecodrain ED3000 series feature:

- Non-wearing magnetic-core level control for optimised and lossfree discharge of condensate.
- Integrated dirt screen between level measurement and drain valve to protect the diaphragm valve with alarm monitoring.
- Diaphragm valve with large cross-section and condensate pilot control for extended service life.
- Potential-free alarm contact (except ED3002, ED3004).



Non-wearing magnetic-core level control

The magnetic-core level control employs fixed switching points to operate the valve. The magnetic core signal transmitter position is detected by non-contact magnetic sensors:

- independently of the condensate type (water/oil).
- independently of the working pressure.

The collection tank integrated in the condensate drain is always used at optimum efficiency. This results in a minimised number of switching cycles and thus, in a maximum service life of the drain valve. No calibration required!

Integrated dirt screen

The dirt screen which is integrated between the level control and the drain valve:

- retains any contaminants that could damage the diaphragm valve.
- triggers an alarm, also if the screen is clogged by dirt.
- allows the drain to be cleaned easily and rapidly.

Therefore, it considerably increases the operating safety of the condensate drain. Since the condensate is pressed through the screen at working pressure, a cleaning will normally not be necessary between maintenance intervals.

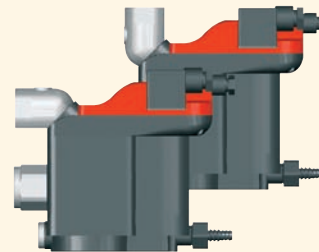

Revolving condensate inlet with additional balance option:

- Condensate line can be connected from top or side.
- Simply rotate the condensate inlet and connect.

The connection for an additional vent line integrated in the top condensate inlet provides completely new connecting options so that condensate can no longer back up into the feed lines.

Easy installation and servicing

- ED3002 can be removed together with the filter bowl remaining on.
- The drain can be removed quickly and easily from its place of installation.
- Servicing can be carried out in a convenient location.
- Cables to install new units can be ready-made.

Therefore, the ecodrain ED3000 series is a real contribution to preventive health care and avoids pain in the knees and back.

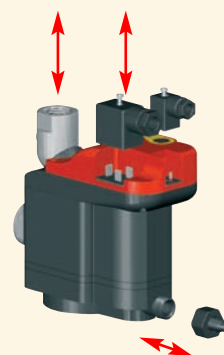

Specifications

Range of application: Compressed air up to 16 bar - normal condensates

Model/Order no.	Compressor aftercooler	Capacity ^{*1}			Max.working pressure	Temperature range	Connections
		Refrigeration dryer	Filter ^{*2}				
ED3002-G230	---	---	720 m ³ /h		16 bar	1 - 60 °C	G 3/8
ED3004-G230	240 m ³ /h	480 m ³ /h	2,400 m ³ /h		16 bar	1 - 60 °C	1 x G 1/2, G 1/8
ED3007-G230	420 m ³ /h	840 m ³ /h	4,200 m ³ /h		16 bar	1 - 60 °C	2 x G 1/2, G 1/8
ED3030-G230	1,800 m ³ /h	3,600 m ³ /h	18,000 m ³ /h		16 bar	1 - 60 °C	2 x G 1/2, G 1/8
ED3100-G230	6,000 m ³ /h	12,000 m ³ /h	60,000 m ³ /h		16 bar	1 - 60 °C	2 x G 1/2, G 1/8

^{*1} referred to 1 bar(a) and 20°C at 7 bar working pressure, suction air compressor 25°C at 60% RH, air discharge temperature aftercooler 35°C, pressure dew-point refrigeration dryer 3°C.

^{*2} Condensate from aftercooler or refrigeration dryer already drained upstream - only for residual oil content or small quantities of condensate

Standard version with BSP thread (G) for 230V/50 - 60Hz supply voltage (230). Alternatively, versions with NPT thread (N) or 115V/50 - 60Hz (115) or 24V/50 - 60Hz (024) are available. 24V DC on request.

Notes on power supply with instable voltage:

We recommend that you use 24VDC units with appropriate power supplies in operating environments with heavily fluctuating mains voltages or high frequency interference (short voltage peaks or voltage drops). This will ensure a reliable long-term operation even where unfavourable power conditions prevail.

Accessories and servicing items:



Plugs (for cable preparation)



Installation kits



Service kits

Dimensional drawings and weights:

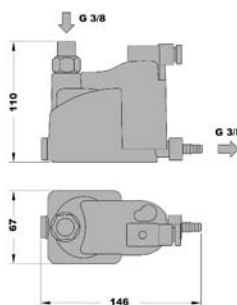

ED3002
0,5 kg

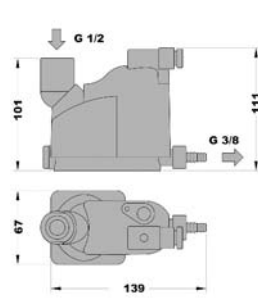

ED3004
0,6 kg

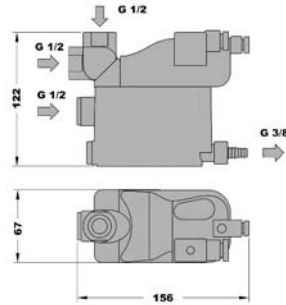

ED3007
1,0 kg

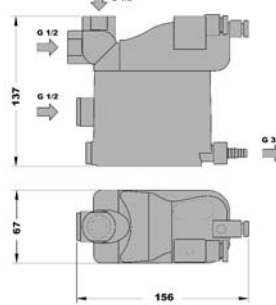

ED3030
1,1 kg

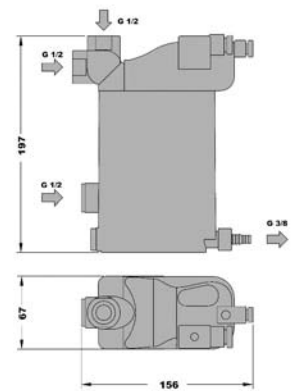

ED3100
1,5 kg

Electronic Condensate Drains

ecodrain ED2000 series

Features and Advantages

Electronic condensate drains of the ecodrain ED2000 series feature:

- Non-wearing magnetic-core level control for optimised and loss-free discharge of condensate.
- Robust and high-pressure resistant metal design. Made of compacted and sealed aluminium. Additional protection with an inside and outside powder coating.
- Diaphragm valve with large cross-section for extended service life
- Potential-free alarm contact.



Robust metal design

All housing components that come into contact with the condensate are made of compacted and sealed metal (Maldaner process) and ensure:

- almost indestructible robustness of the product.
- extreme resistance to aggressive media (up to pH 3).

Therefore, the ecodrain ED2000 series is suitable not only for applications with up to 50 bar but also for use with certain industrial gases. A special CO₂ version is available for gaseous carbon dioxide at pressures of up to 25 bar.

Heater

A frost proof option is available with:

- Thermostat-controlled heater.
- Insulating shells.

The ecodrain ED2000 series complies with protection class IP65 and is therefore suitable for outdoor installation and, in combination with the optional heater, even for installation in outdoor environments where there is a possibility of frost.

Non-wearing magnetic-core level control

The magnetic-core level control employs fixed switching points to operate the valve. The magnetic core signal transmitter position is detected by non-contact magnetic sensors:

- independently of the condensate type (water/oil).
- independently of the working pressure.

The collection tank integrated in the condensate drain is always used at optimum efficiency.

This results in a minimised number of switching cycles and thus, in a maximum service life of the drain valve. No calibration required!



Specifications

Range of application: Compressed air and (certain) industrial gases up to 50 bar - normal and problematic condensates

Model/Order no.	Capacity ^{*1}			Max.working pressure	Temperature range	Connections
	Compressor aftercooler	Refrigeration dryer	Filter ^{*2}			
ED2010-G230	1,290 m ³ /h	2,580 m ³ /h	12,900 m ³ /h	16 bar	1 - 60 °C	2 x G 1/2
ED2020-G230	6,000 m ³ /h	12,000 m ³ /h	60,000 m ³ /h	16 bar	1 - 60 °C	3 x G 3/4
ED2060-G230	66,000 m ³ /h	132,000 m ³ /h	660,000 m ³ /h	16 bar	1 - 60 °C	3 x G 3/4
ED2010/25-G230	1,290 m ³ /h	2,580 m ³ /h	12,900 m ³ /h	25 bar	1 - 60 °C	2 x G 1/2
ED2020/25-G230	6,000 m ³ /h	12,000 m ³ /h	60,000 m ³ /h	25 bar	1 - 60 °C	3 x G 3/4
ED2060/25-G230	66,000 m ³ /h	132,000 m ³ /h	660,000 m ³ /h	25 bar	1 - 60 °C	3 x G 3/4
ED2010/40-G230	1,290 m ³ /h	2,580 m ³ /h	12,900 m ³ /h	40 bar	1 - 60 °C	2 x G 1/2
ED2020/40-G230	6,000 m ³ /h	12,000 m ³ /h	60,000 m ³ /h	40 bar	1 - 60 °C	3 x G 3/4
ED2060/40-G230	66,000 m ³ /h	132,000 m ³ /h	660,000 m ³ /h	40 bar	1 - 60 °C	3 x G 3/4
ED2010/50-G230	1,290 m ³ /h	2,580 m ³ /h	12,900 m ³ /h	50 bar	1 - 60 °C	2 x G 1/2
ED2010/25-G230/CO ₂	1,290 m ³ /h	2,580 m ³ /h	12,900 m ³ /h	25 bar	1 - 60 °C	2 x G 1/2
ED2020/25-G230/CO ₂	6,000 m ³ /h	12,000 m ³ /h	60,000 m ³ /h	25 bar	1 - 60 °C	3 x G 3/4
ED2060/25-G230/CO ₂	66,000 m ³ /h	132,000 m ³ /h	660,000 m ³ /h	25 bar	1 - 60 °C	3 x G 3/4

^{*1} referred to 1 bar(a) and 20°C at 7 bar working pressure, suction air compressor 25°C at 60% RH, air discharge temperature aftercooler 35°C, pressure dew-point refrigeration dryer 3°C

^{*2} Condensate from aftercooler or refrigeration dryer already drained upstream – only for residual oil content or small quantities of condensate

Standard version with BSP thread (G) for 230V/50 - 60Hz supply voltage (230).

Alternatively, versions with NPT thread (N) or 115V/50 - 60Hz (115) or 24V/50 - 60Hz (024) are available.

24V DC on request

Accessories and servicing items:



Heater



Installation kits



Service kits

Dimensional drawings and weights:

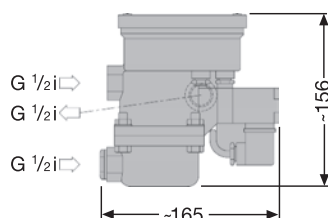

ED2010

2 kg

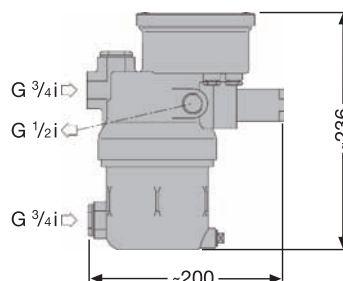

ED2020

2,9 kg

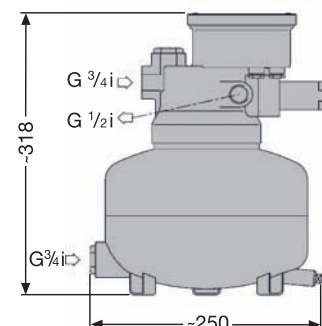

ED2060

9,4 kg

Why Electronic Condensate Drains?

Electronic condensate drains with level control ensure lossfree condensate discharge

The condensate accumulates in the collection tank (1) integrated in the electronic condensate drain. An electronic level controller (2) continuously monitors the level. When the maximum level is reached, the electric drain valve (3), which is also integrated in the condensate drain, will open and thus drain the condensate from the compressed air system. When a minimum level is reached, the valve closes in time before compressed air can escape. This prevents the loss of compressed air.

Electronic condensate drains with diaphragm valves discharge condensate reliably.

Condensate drainage via a diaphragm valve with large cross-section (4) ensures that contaminants are flushed out and thus ensures a long service

life and fault-free operation of the valve. At the same time, condensate is prevented from forming an emulsion that would need expensive condensate treatment.

Electronic condensate drains with alarm contact monitor condensate drainage

If a fault has occurred, i.e. if the condensate cannot be discharged, the electronic control board (5) of the condensate drain generates an alarm signal. This allows timely detection and avoidance of damage caused by condensate to the downstream compressed air system or to the production, which may sometimes lead to immense costs.

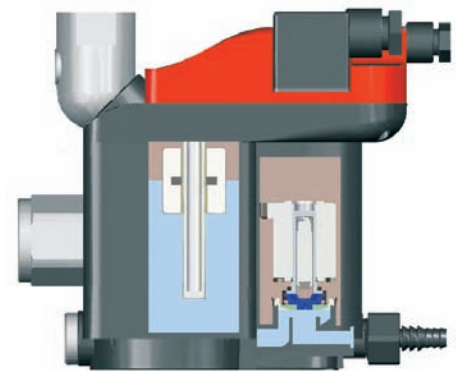
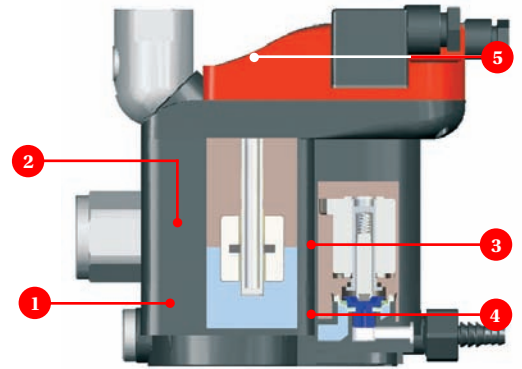

Time-controlled condensate drains waste energy and money

If the control of a condensate drain is not level controlled but exclusively time-based, it employs preset values for valve operating times and intervals. However, since the amount of condensate in a compressed air system changes constantly (e.g. summer/winter, maximum/part load), the following problems arise with time-controlled condensate drains:

- Valve operating time is set too short, or operating intervals are too long: Not enough condensate is drained. COMPRESSED AIR SYSTEM BACKS UP.
- Valve operating time is set too long, or operating intervals are too short: The valve remains open although all the condensate has been drained. COMPRESSED AIR ESCAPES.
- High switching frequency because the condensate collection tank is too small: Premature failure without possibility of servicing. COMPRESSED AIR SYSTEM BACKS UP.
- Small valve nozzles are very susceptible to contaminations: Valve can no longer close – COMPRESSED AIR ESCAPES CONTINUOUSLY.

Basis of the calculation:

- Valve aperture cross-section: \varnothing 3 mm
- Resulting flow rate at 8 bar: 600 litres/min
- Equivalent compressor power: 4.4 kW
- Energy costs: 0.07 €/kWh

Costs of compressor air

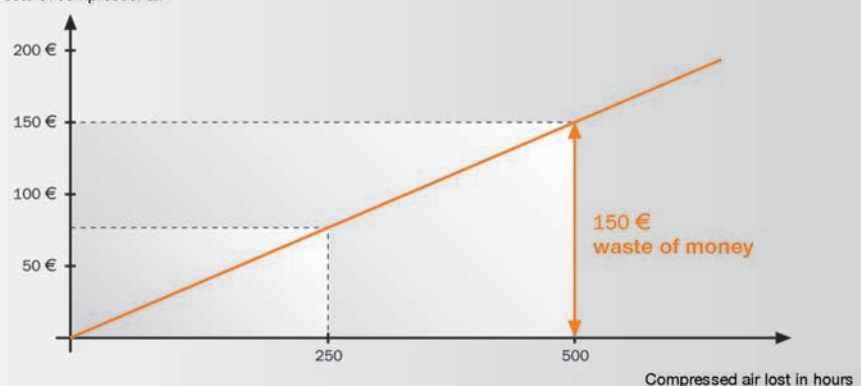

Dimensioning Electronic Condensate Drains

When dimensioning condensate drains, it must be taken into account that different quantities of condensate need to be drained from the aftercoolers (the condensate is drained from the aftercooler itself, a cyclone separator located downstream, or the pressure vessel), the refrigeration dryers (condensate is usually drained within the dryer itself) and from the filters (residual oil contents or small quantities of condensate).

1. Standard dimensioning

Standard dimensioning is based on the following reference conditions:

Ambient (suction) air compressor: 25°C and 60% relative humidity
 Working pressure: 7 bar
 Air discharge temperature aftercooler: 35°C
 Pressure dew-point refrigeration dryer: 3°C

The volume capacities stated in the technical specifications for the aftercooler, refrigeration dryer and the filter were calculated with these conditions.

Example:

Compressor(s) with 2,000 m³/h (1 bar(a), 20°C), operated under the above reference conditions

Drain aftercooler: ED3100 (1,800 - 6,000 m³/h) or ED2020 (1,290 - 6,000 m³/h)
 Drain refrigeration dryer: ED3030 (840 - 3,600 m³/h) or ED2010 (up to 2,580 m³/h)
 Drain filter: ED3004 (720 - 2,400 m³/h) or ED2010 (up to 12,900 m³/h)

2. Extended dimensioning

This extended method allows the dimensioning to be adapted to climatic conditions and operating pressures that vary from the reference conditions.

Working pressure	Ambient/Suction conditions (average summer temperature/relative humidity)									
	Compressor/Aftercooler					Refrigeration dryer				
	15°C 40%	20°C 50%	25°C 60%	30°C 70%	35°C 80%	15°C 40%	20°C 50%	25°C 60%	30°C 70%	35°C 80%
4 bar	16.5	3.4	1.5	0.8	0.5	2.6	1.8	1.3	1.0	0.7
6 bar	4.8	2.1	1.1	0.6	0.4	3.6	2.5	1.8	1.4	1.0
8 bar	3.4	1.7	0.9	0.6	0.4	4.7	3.3	2.4	1.8	1.3
10 bar	2.9	1.5	0.9	0.5	0.3	5.7	4.0	2.9	2.2	1.6
12 bar	2.6	1.4	0.8	0.5	0.3	6.8	4.7	3.4	2.6	1.9
14 bar	2.5	1.3	0.8	0.5	0.3	7.8	5.5	4.0	2.9	2.2
16 bar	2.4	1.3	0.8	0.5	0.3	8.9	6.2	4.5	3.3	2.5
25 bar	2.1	1.2	0.7	0.5	0.3	13.5	9.5	6.9	5.1	3.9
50 bar	1.9	1.1	0.7	0.4	0.3	26.6	18.6	13.5	10.0	7.6

All correction factors refer to the capacity of the drains on the aftercooler; they have been calculated for an aftercooler discharge temperature of +10°C above ambient/suction temperature and 3°C pressure dew-point of the refrigeration dryer.

Example:

Compressor(s) with 2,000 m³/h (1 bar(a), 20°C), operated at 10 bar working-pressure. The average day temperature in summer is 30°C with 70% relative humidity.

Correction factor aftercooler: 0.5 (see table)

Correction factor refrigeration dryer: 2.2 (see table)

Correction factor filter: always 10

Drain aftercooler: 2,000 m³/h ÷ 0.5 = 4,000 m³/h (referred to compressor/aftercooler capacity)

Drain refrigeration dryer: 2,000 m³/h ÷ 2.2 = 910 m³/h (referred to compressor/aftercooler capacity)

Drain filter: 2,000 m³/h ÷ 10 = 200 m³/h (referred to compressor/aftercooler capacity)

Drain aftercooler: ED3100 (1,800 - 6,000 m³/h) or ED2020 (1,290 - 6,000 m³/h)

Drain refrigeration dryer: ED3030 (420 - 1,800 m³/h) or ED2010 (up to 1,290 m³/h)

Drain filter: ED3004 (up to 240 m³/h) or ED2010 (up to 1,290 m³/h)

Parker Worldwide

AE – UAE, Dubai
Tel: +971 4 8127100
parker.me@parker.com

AR – Argentina, Buenos Aires
Tel: +54 3327 44 4129

AT – Austria, Wiener Neustadt
Tel: +43 (0)2622 23501-0
parker.austria@parker.com

AT – Eastern Europe, Wiener Neustadt
Tel: +43 (0)2622 23501 900
parker.easteurope@parker.com

AU – Australia, Castle Hill
Tel: +61 (0)2-9634 7777

AZ – Azerbaijan, Baku
Tel: +994 50 2233 458
parker.azerbaijan@parker.com

BE/LU – Belgium, Nivelles
Tel: +32 (0)67 280 900
parker.belgium@parker.com

BR – Brazil, Cachoeirinha RS
Tel: +55 51 3470 9144

BY – Belarus, Minsk
Tel: +375 17 209 9399
parker.belarus@parker.com

CA – Canada, Milton, Ontario
Tel: +1 905 693 3000

CH – Switzerland, Etoy
Tel: +41 (0)21 821 87 00
parker.switzerland@parker.com

CL – Chile, Santiago
Tel: +56 2 623 1216

CN – China, Shanghai
Tel: +86 21 2899 5000

CZ – Czech Republic, Klecany
Tel: +420 284 083 111
parker.czechrepublic@parker.com

DE – Germany, Kaarst
Tel: +49 (0)2131 4016 0
parker.germany@parker.com

DK – Denmark, Ballerup
Tel: +45 43 56 04 00
parker.denmark@parker.com

ES – Spain, Madrid
Tel: +34 902 330 001
parker.spain@parker.com

FI – Finland, Vantaa
Tel: +358 (0)20 753 2500
parker.finland@parker.com

FR – France, Contamine s/Arve
Tel: +33 (0)4 50 25 80 25
parker.france@parker.com

GR – Greece, Athens
Tel: +30 210 933 6450
parker.greece@parker.com

HK – Hong Kong
Tel: +852 2428 8008

HU – Hungary, Budapest
Tel: +36 1 220 4155
parker.hungary@parker.com

IE – Ireland, Dublin
Tel: +353 (0)1 466 6370
parker.ireland@parker.com

IN – India, Mumbai
Tel: +91 22 6513 7081-85

IT – Italy, Corsico (MI)
Tel: +39 02 45 19 21
parker.italy@parker.com

JP – Japan, Tokyo
Tel: +81 (0)3 6408 3901

KR – South Korea, Seoul
Tel: +82 2 559 0400

KZ – Kazakhstan, Almaty
Tel: +7 7272 505 800
parker.easteurope@parker.com

MX – Mexico, Apodaca
Tel: +52 81 8156 6000

MY – Malaysia, Shah Alam
Tel: +60 3 7849 0800

NL – The Netherlands, Oldenzaal
Tel: +31 (0)541 585 000
parker.nl@parker.com

NO – Norway, Asker
Tel: +47 66 75 34 00
parker.norway@parker.com

NZ – New Zealand, Mt Wellington
Tel: +64 9 574 1744

PL – Poland, Warsaw
Tel: +48 (0)22 573 24 00
parker.poland@parker.com

PT – Portugal, Leca da Palmeira
Tel: +351 22 999 7360
parker.portugal@parker.com

RO – Romania, Bucharest
Tel: +40 21 252 1382
parker.romania@parker.com

RU – Russia, Moscow
Tel: +7 495 645-2156
parker.russia@parker.com

SE – Sweden, Spånga
Tel: +46 (0)8 59 79 50 00
parker.sweden@parker.com

SG – Singapore
Tel: +65 6887 6300

SK – Slovakia, Banská Bystrica
Tel: +421 484 162 252
parker.slovakia@parker.com

SL – Slovenia, Novo Mesto
Tel: +386 7 337 6650
parker.slovenia@parker.com

TH – Thailand, Bangkok
Tel: +662 717 8140

TR – Turkey, Istanbul
Tel: +90 216 4997081
parker.turkey@parker.com

TW – Taiwan, Taipei
Tel: +886 2 2298 8987

UA – Ukraine, Kiev
Tel: +380 44 494 2731
parker.ukraine@parker.com

UK – United Kingdom, Warwick
Tel: +44 (0)1926 317 878
parker.uk@parker.com

US – USA, Cleveland
Tel: +1 216 896 3000

VE – Venezuela, Caracas
Tel: +58 212 238 5422

ZA – South Africa, Kempton Park
Tel: +27 (0)11 961 0700
parker.southafrica@parker.com

Ed. 2010-06-29

European Product Information Centre
Free phone: 00 800 27 27 5374
(from AT, BE, CH, CZ, DE, EE, ES, FI, FR, IE, IL, IS, IT, LU, MT, NL, NO, PT, SE, SK, UK)



Parker Hannifin Corporation
ZANDER Aufbereitungstechnik GmbH
Im Teelbruch 118
D-45219 Essen
Tel: +49 (0) 2054 934-0
Fax: +49 (0) 2054 934-164
www.zander.de